

# FENCING



# BEFORE YOU START, READ THIS

- ✓ This installation guide does not cover fences above 1.8 metres, please seek advice from your supplier
- ✓ Describe your site details when ordering materials (see 'Site Details' section below)
- ✓ Identify the soil type for your fence site. Refer to the Table in Step 1. This will determine the concrete required for the job
- ✓ Make sure you know the whereabouts of underground electricity, gas or water mains before you begin digging. Ring 1100 'Dial before you dig'
- ✓ Check your local council regulations on boundary fencing
- ✓ Ensure you read through this guide completely before you begin to ensure you fully understand the installation process
- ✓ Check the delivered material for the correct number of components and general condition.



## IMPORTANT

It is recommended that the reader pays particular attention to those items identified as IMPORTANT in this brochure to ensure satisfactory long-term performance. These items include:

- Ensure post holes are of correct size and filled with concrete (see step 1)
- Ensure that the recommended number of self-drilling screws are used to join two posts together (see step 2).

## EQUIPMENT REQUIREMENTS

### Tools\*

- Self drilling screw gun with clutch system (electrical or battery operated)
- Spirit Level or Magnetic Level
- Rubber Mallet
- String Line & Marker Pegs
- Scissor Shovel and/or Spade
- Wheelbarrow and Larry Hoe

- Spud Bar
- Earth Leakage Circuit Breaker.

### Personal Protective Equipment\*

- Safety Glasses
- Protective Gloves
- Hat & Sun lotion for skin protection
- Appropriate safety footwear
- Ear Muffs (if cutting required)
- Overalls (if cutting required).

### Optional Equipment\*

- Nibbler (if cutting required)
- Tin Snips (if cutting required)
- Tungsten tipped Handcutter (if vertical slitting of sheets required)
- Concrete Mixer.

\*(Most pieces of equipment are available for hire at tool hire centres.)

## SITE DETAILS

Fencing made from COLORBOND® steel is designed to withstand most wind conditions. The wind on the fence at your site will depend on a number of factors, including where you live (see question b) and the number of surrounding properties (see question a).

THESE DETAILS WILL HELP YOUR COLORBOND® STEEL FENCE DISTRIBUTOR TAILOR A DESIGN THAT'S BEST FOR YOU.

If in proximity to severe marine conditions or bounding swimming pools please seek specific advice from BlueScope Steel Direct on 1800 022 999.

### a. What does your property look like?

Typically having numerous closely spaced obstructions, such as houses or developed trees. These areas may have roads and canals less than 200m wide and open spaces less than 250,000 sqm.

Example: Typical suburban housing development which may include parks or lakes.

*Choose the site that best resembles your area.*



Typically has few trees and isolated obstructions. Example: Fronting open areas unlikely to be developed in the next two years.



### b. Where do you live?

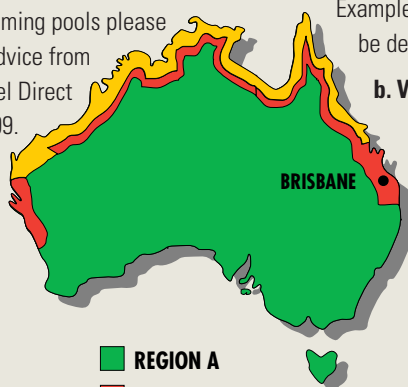

- REGION A
- REGION B
- OTHER

# A STEP BY STEP GUIDE TO INSTALLATION

## STEP 1 – MARKING OUT YOUR POST HOLES

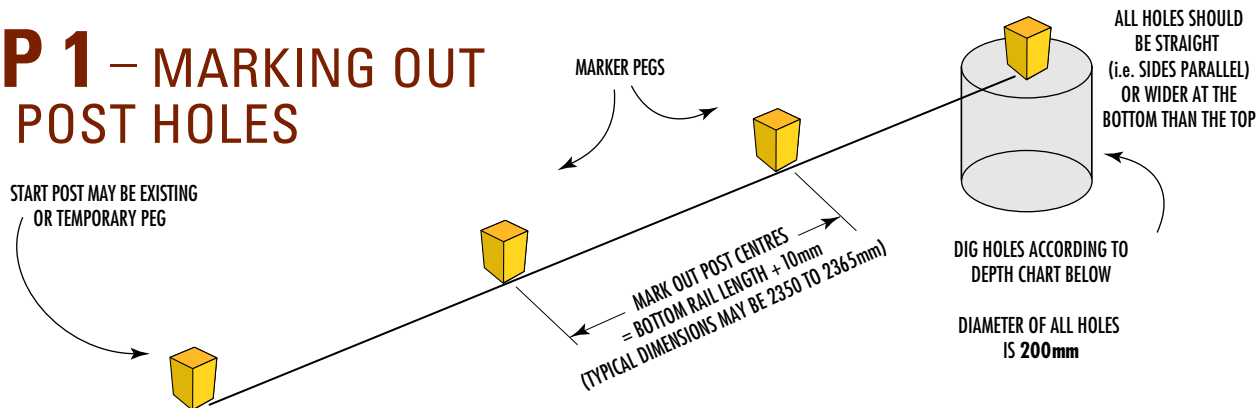

 <b>IMPORTANT</b>	SOIL TYPE	MINIMUM HOLE DEPTH	APPROXIMATE CONCRETE REQUIRED
	Post lengths required will increase accordingly to cater for these ground conditions	Rock	300mm
	Clay/Firm Earth	600mm	2 Bags per hole (20kg bags)
	Sand/Loose Fill	900mm	3 Bags per hole (20kg bags)

## SLOPING OR UNEVEN SITES

### ADDITIONAL INFORMATION

It's highly recommended that you invest a small amount of extra effort to rake your fence on sloping or uneven ground rather than stepping the panels. It achieves a better overall appearance as well as providing a stronger fence.

### A) MARKING OUT SLOPING SITES

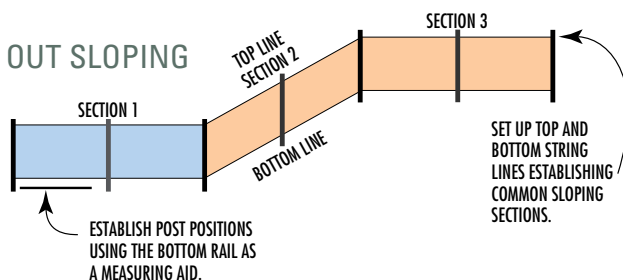

### UNEVEN SITES

Vertical slitting of sheets may be required if slope is greater than 1 in 8. This may reduce the three sheet coverage to a point where one of the sheets may require vertical slitting. On COLORBOND® steel and ZINCALUME® steel this can be achieved using a straight edge and scoring with a tungsten tipped hand cutter available at most hardware stores, then bending and snapping the sheet.

The top rail angles can be adjusted to create a smoother angle if desired. Note that the post height required will increase, so allow for this when fixing the posts in the ground.

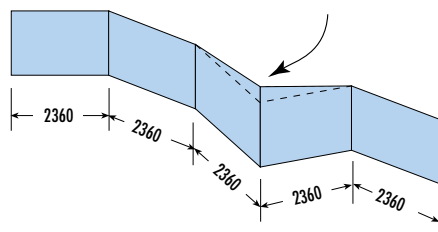

### B) CUTTING OF SHEETS FOR A RAKED FENCE

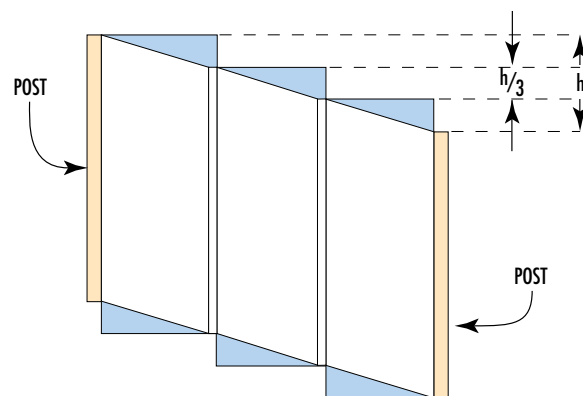

The preferred method of cutting sheets is to use a nibbler or tin snips.



# STEP 2 – SECURING POSTS

## A) FASTENING POSTS TOGETHER

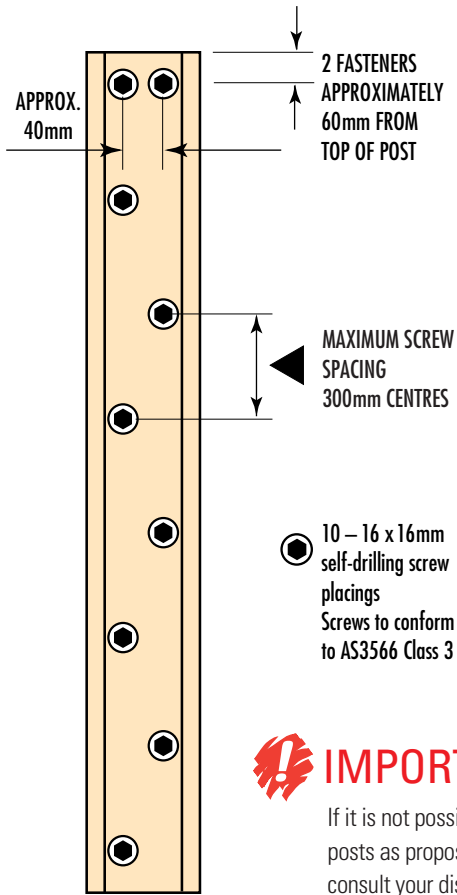

If it is not possible to fix posts as proposed here please consult your distributor.

## B) FIXING POST IN GROUND

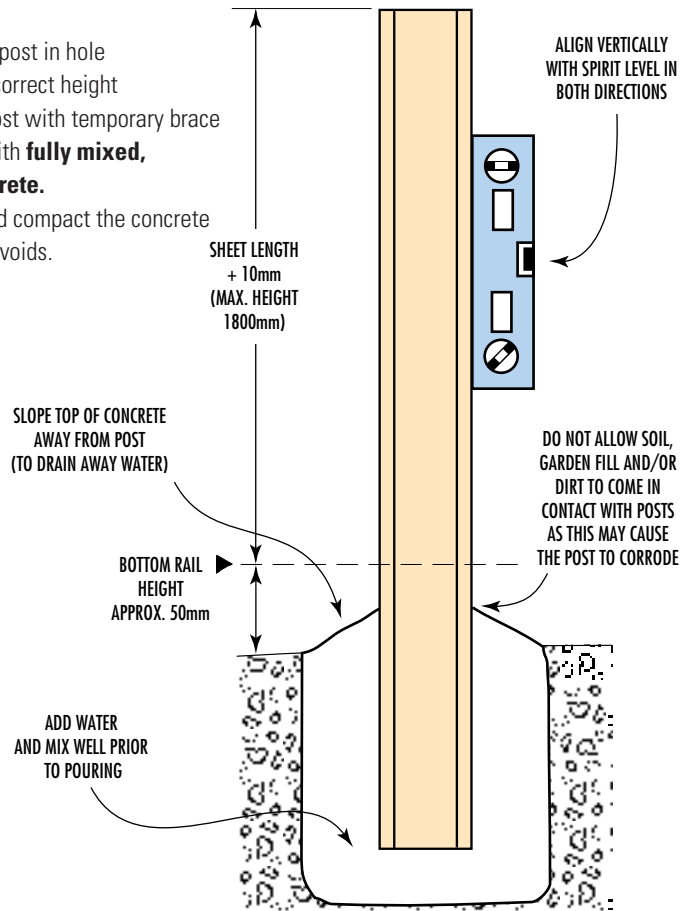

## END POSTS, CORNER POSTS AND JUNCTIONS

- = SHS Section
- └ = Fence Post

Dimensions of the SHS section and fence posts will vary according to the fence supplies. Contact your distributor for details.

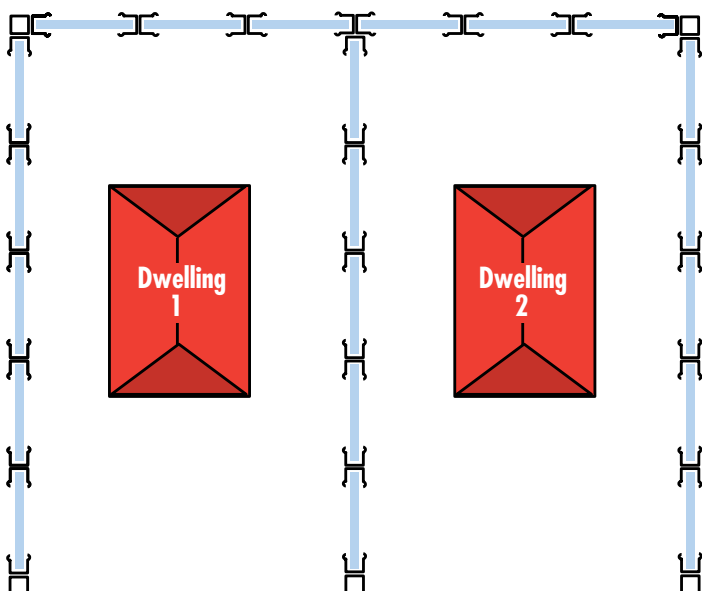
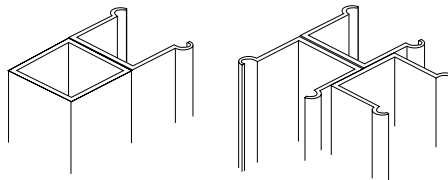

## TAPERING THE FRONT OF YOUR FENCE

It is highly recommended that you taper the last two panels of your fence at an unsupported end, particularly where your fence extends beyond the front of your house.

Cut sheets as per the instructions in the 'sloping or uneven sites' section.

The minimal extra effort in tapering the unsupported end will provide a better looking fence than a stepped fence and is much stronger than leaving it at full height.

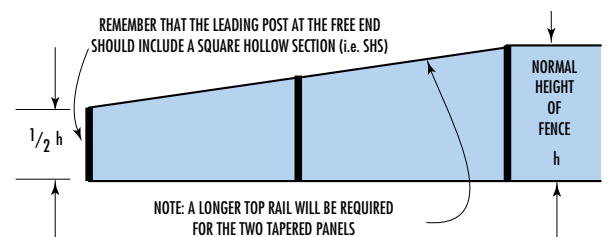

	Fence Height	Tapered End Height	Top rail length if tapered per two panels
Example for 2365mm post centres	1500mm	750mm	2385mm
	1800mm	900mm	2400mm



# STEP 3 – INSTALLING INFILL SHEETS

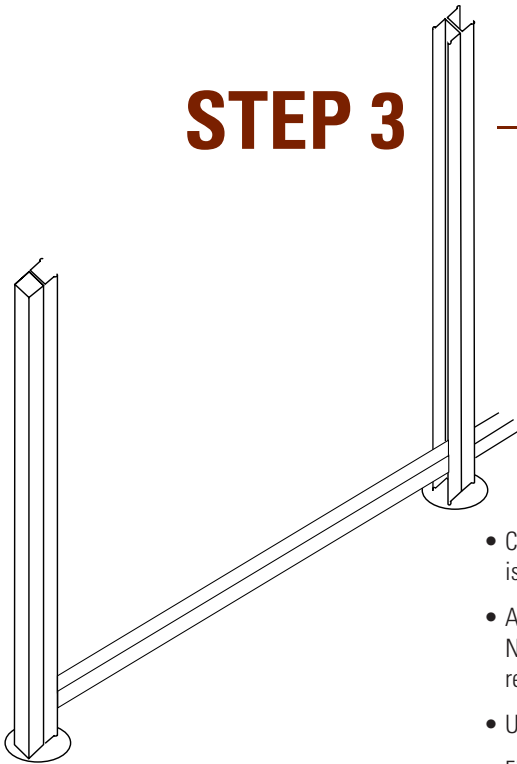

- Insert bottom rail between posts to determine exact locations of next post
- Adjust bottom rail to correct height – it is important to maintain a minimum gap of 50mm between bottom of rail and ground
- Screw fix the rails at this stage
- Place top rail into post and fix with self drilling screws on both sides of posts. Ensure that the self drilling screws are not full tightened, as they need to be removed when inserting sheets. Ensure the position of the top rail is protruding 2mm above the top of the posts to reduce the risk of injury

- Continue this procedure until fence length is achieved
- Allow the concrete to cure overnight. Note: Longer curing period may be required in very cold and/or wet weather
- Unscrew top rail and remove
- Fit infill sheets into bottom rail ensuring correct lap as per diagrams below
- Place top rail on infill sheets working from one end to the other, locating the profile in the rail. A gentle tap with a rubber mallet may help
- Secure the top rail with self drilling screws on both sides
- Hose down with good water pressure when finished to remove any swarf such as drill filings or remnants from the nibbling process and
- Check installation.

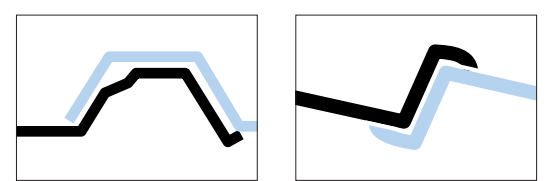
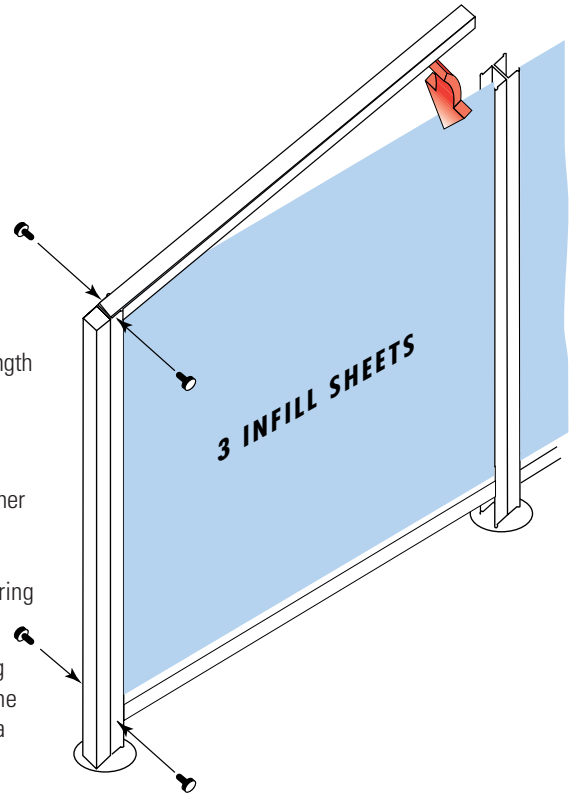

CORRECT LAP DETAIL FOR VARIOUS INFILL SHEET PROFILES

## MAINTENANCE AND WARRANTY OF YOUR FENCE

- To keep your fence looking its best, simply hose your fence down periodically with water when washing the car or watering the garden. A soft broom should be sufficient to remove any cobwebs. Pay particular attention to the area under the top rail, which is sheltered from natural washing by rain.
- Do not** build up soil, garden fill and/or dirt against the bottom rails and posts of your fence as this will retain water and lead to corrosion.  
  
**Do not** use your fence as a retaining wall, as it is not designed for this purpose.

- Avoid spraying the fence with garden sprays or fertilisers as these can damage the surface. If this occurs wash the fence down with water.  
  
Adequate drainage is needed to ensure that water does not pond in the bottom rail and to assist in the removal of debris. This is often achieved by pre-punched holes in the bottom rail, or by designing the posts such that there is a clearance between the ends of the bottom rail and the posts.
- Do not use touch up paint. Minor scratches should be left alone or the infill sheet replaced. Touch up paint will weather differently than COLORBOND® steel.

- Fencing is backed by a 10 year warranty under the following conditions:
  - Installation > 1km from Marine or Industrial environment
  - Fence is installed to Manufacturer's guidelines
  - Fence is maintained regularly in accordance with BlueScope Steel guidelines.



# INSIST ON COLORBOND® STEEL FOR YOUR FENCE

COLORBOND® steel has a well-earned reputation for quality and durability.

That's why when buying pre-painted steel fencing from a fencing manufacturer or supplier, you should always insist the steel is COLORBOND® steel.

The technology behind COLORBOND® steel is world leading – and it was developed right here in Australia to withstand the harsh climate conditions of Australia.

1. First, a base of ZINCALUME® steel ensures outstanding anti-corrosion performance
2. Next, a conversion layer is chemically applied to enhance coating adhesion
3. Then, an epoxy primer is baked onto the surface
4. And finally, a durable, exterior grade top-coat is baked on.



This installation guide utilises information provided by manufacturers of cold-formed steel residential fencing. It has been circulated to the steel fencing industry for feedback and comments prior to publication. Whilst care has been taken in the preparation and compilation of the material contained herein, no responsibility or liability shall be accepted by the Authors and/or BlueScope Steel for any use to which it is put. Information contained in this installation guide is subject to change without notice.

## This simple checklist is your guarantee of the superior BlueScope Steel difference:

- ☑ Made only by BlueScope Steel in Australia for Australian conditions
- ☑ Backed by a 10 year BlueScope Steel warranty\*
- ☑ Infill sheets feature a corrosion resistant base made from ZINCALUME® steel
- ☑ Wide colour range
- ☑ Meeting Australian Standards (AS 1397 and AS 2728). Guarantees coating mass and paint film thickness

To make sure your product is from BlueScope Steel, look for the COLORBOND® steel brand mark.



COLORBOND® and ZINCALUME® are registered trade marks of BlueScope Steel Limited. BlueScope is a registered trade mark of BlueScope Steel Limited.

© 2003 by BlueScope Steel Limited. All rights reserved. No part of this brochure may be reproduced, stored in a retrieval system, or transmitted in any form or by any means, electronic, mechanical, photocopying, recording or otherwise, without written permission of BlueScope Steel Limited.

BlueScope Steel Limited ABN 16 000 011 058

Sydney (02) 9795 6700  
Melbourne (03) 9586 2222  
Brisbane (07) 3845 9300  
Adelaide (08) 8243 7333  
Perth (08) 9330 0666

\*Warranty conditions apply. Ask your fencing supplier for details. Clemenger/BSL5198/November 05 (P33)



COLOUR CHOICES



HI-TECH PRODUCTION



DURABILITY



DESIGN FLEXIBILITY



ENVIRONMENTALLY FRIENDLY



WARRANTY



9 320075 041182

For further information please phone BlueScope Steel Direct on 1800 022 999 or visit [www.colorbond.com](http://www.colorbond.com) or [www.zincalume.com](http://www.zincalume.com)